

1

2

3

4

5

6

7

8

No.	Part Name	Q'ty	Material	Processing・Finish	Remarks
-----	-----------	------	----------	-------------------	---------

A

A

B

B

C

C

D

D

E

E

F

F

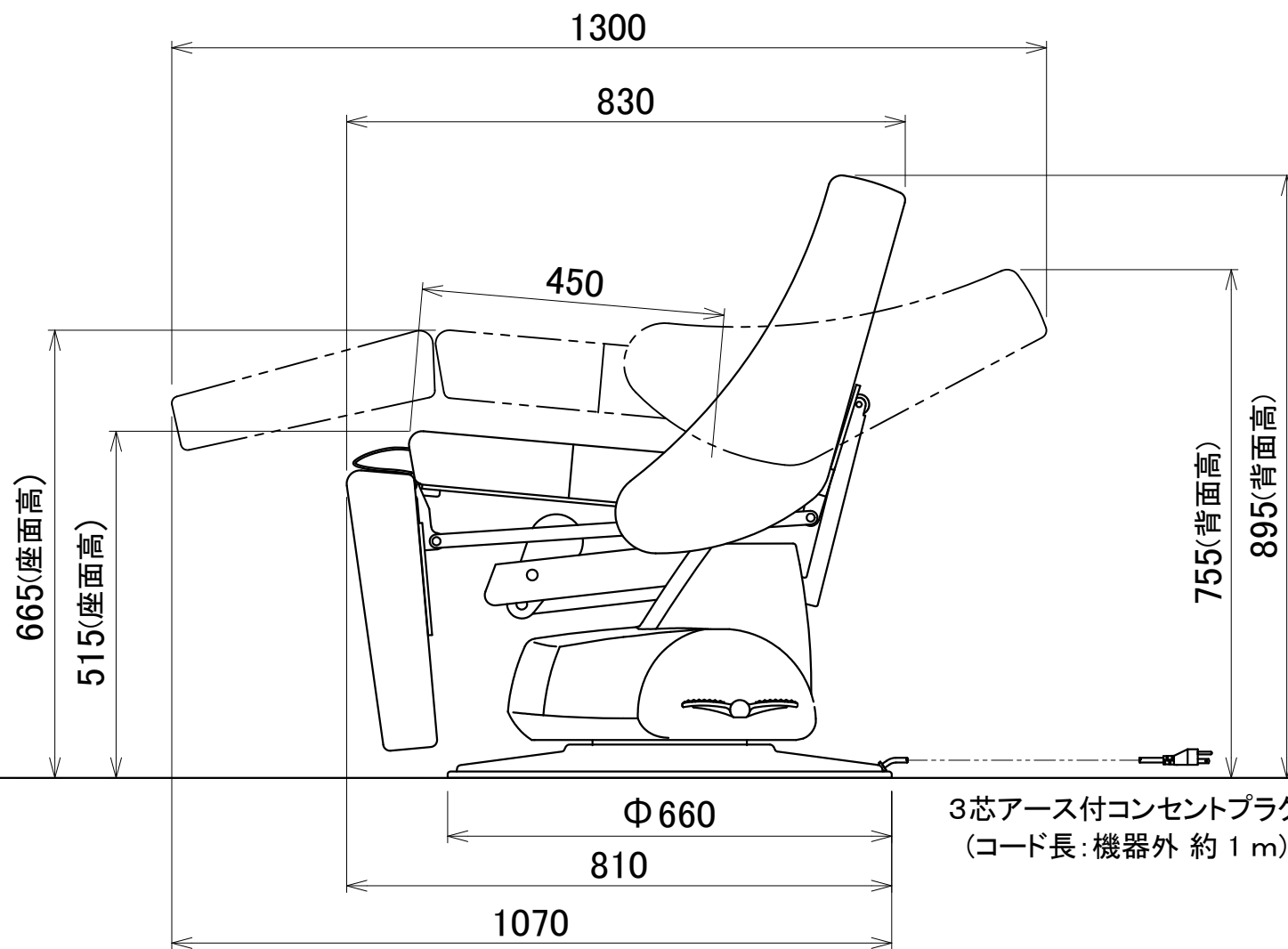
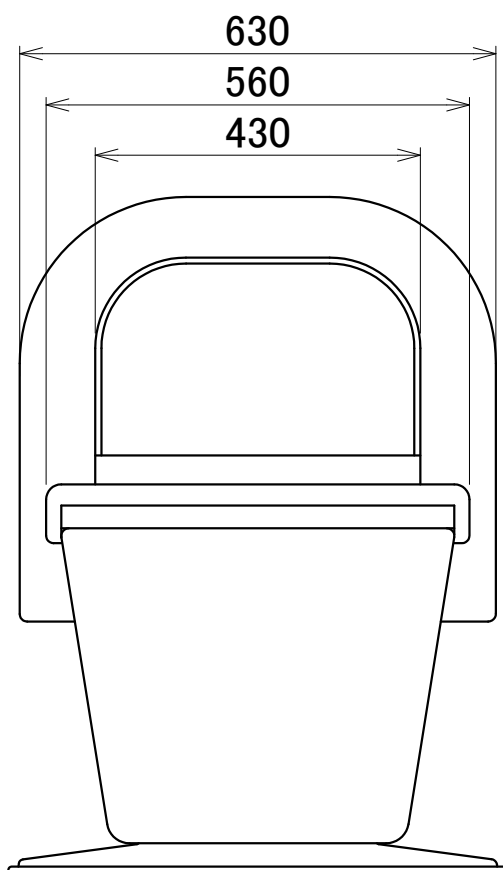
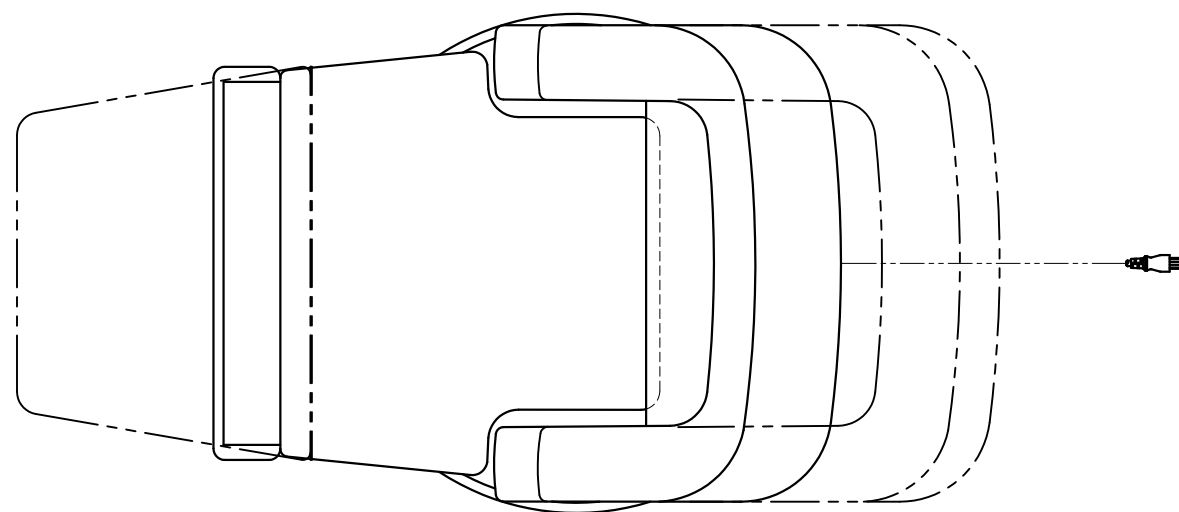

3芯アース付コンセントプラグ
(コード長: 機器外 約 1 m)

Mark	Date	Revisions	Drawn	Approved

3rd angle projection method		BEAUTY GARAGE			Product name 電動シャンプーチェアRUBINO-SR	
		Approved	Checked	Drawn	Date: 2023/02/08	Category シャンプーチェア
measurement unit: mm				marukusu	Scale: 1:10(A3)	BG Model No.: 100000*
		Title 寸法図			Version: 01	Sheet No.: 1/1

1

2

3

4

5

6

7

8